

## LARA 106 bracciolo basso / bras bas

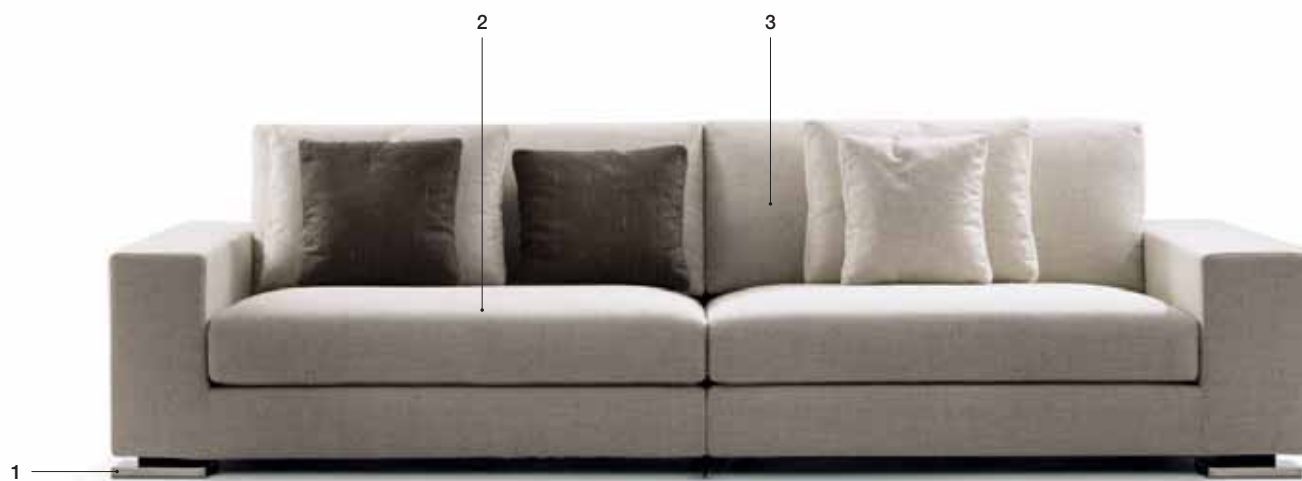

### VERSIONE STANDARD / VERSION STANDARD:

1. Piede basso in acciaio lucido h. cm. 5. 2. Cuscini seduta in "POLIDAC". 3. Cuscini schienale in "POLIDAC".  
 1. Pied bas en acier poli h. cm. 5. 2. Coussins assise en "POLIDAC". 3. Coussins dos en "POLIDAC".

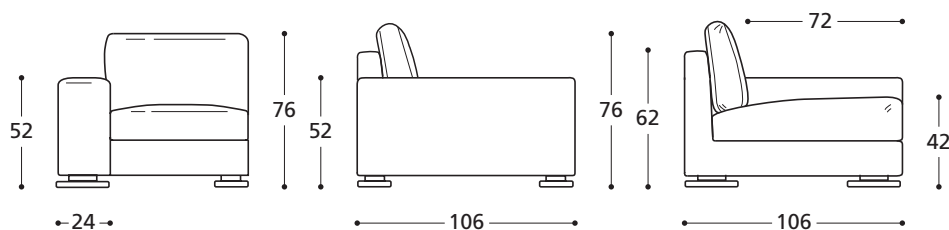

**ATTENZIONE!** Le misure sono assolutamente indicative perchè riferite ad elementi imbottiti e sagomati.  
**ATTENTION!** Les mesures sont absolument indicatives car elles désignent des éléments rembourrés et façonnés.

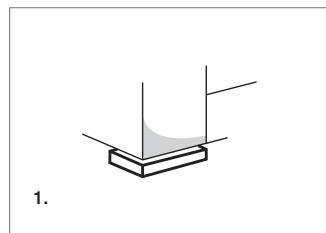

### PIEDE STANDARD / PIED STANDARD

Piede basso in acciaio lucido h. cm. 5.  
 Pied bas en acier poli h. cm. 5.

### OPTIONAL / OPTIONS:

- A. Cuscini seduta versione "ALTA DENSITÀ".  
 Coussins assise en "HAUTE DENSITÉ".
- B. Piede BASSO in legno tinta wengè h. cm. 5.  
 Pied BAS en bois teinté wengé h. cm. 5.
- C. Piede INVISIBILE in legno tinta wengè h. cm. 5.  
 Pied INVISIBLE en bois teinté wengé h. cm. 5.

- D. Piede ALTO A PONTE in metallo cromato h. cm. 10. **ATTENZIONE:** con l'utilizzo di questo piede si modificano le altezze, compresa la seduta, di cm. 5.  
 Pied HAUT À PONT en métal chromé h. cm. 10. **ATTENTION:** l'utilisation de ce pied implique la modification des hauteurs, assise comprise, de cm. 5.
- E. Piede ALTO in legno tinta wengè h. cm. 9. **ATTENZIONE:** con l'utilizzo di questo piede si modificano le altezze, compresa la seduta, di cm. 4.  
 Pied HAUT en bois teinté wengé h. cm. 9. **ATTENTION:** l'utilisation de ce pied implique la modification des hauteurs, assise comprise, de cm. 4.

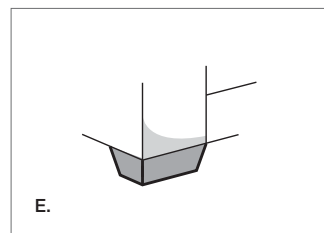
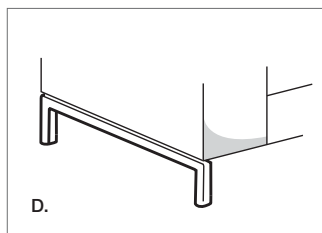
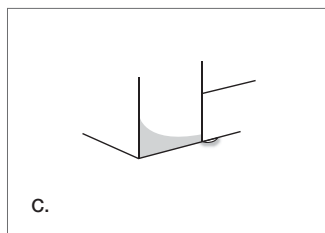
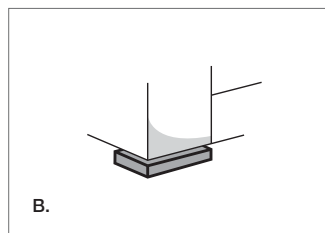
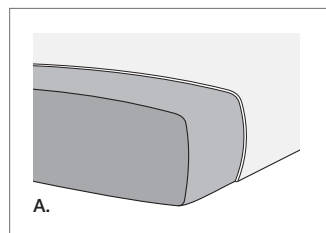

### ELEMENTO SOSPESO ÉLÉMENT SUSPENDU

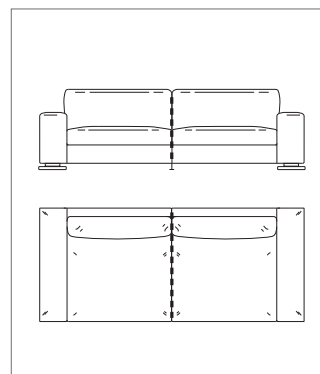

- Gli elementi sospesi (identificati dal tratteggio) si uniscono con un piede di giunzione invisibile da avvitare.
- Non possono essere uniti ad elementi / elementi terminali.
- Les éléments suspendus (marqués de hachures) se combinent avec un pied de cavalier invisible à visser.
- Ils ne peuvent pas être joints à des éléments / éléments terminaux.

### ELEMENTO / ELEM. TERMINALE ÉLÉMENT / ÉLÉMENT TERMINAL

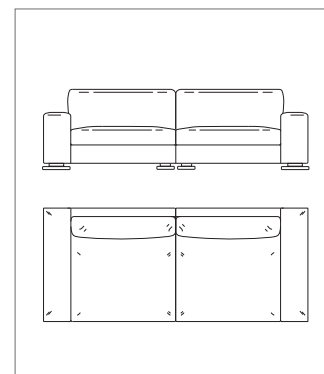

- Gli elementi / elementi terminali si accostano e si uniscono con un gancio rapido, maschio / femmina.
- Non possono essere uniti ad elementi sospesi.
- Les éléments / éléments terminaux se ferment et se rejoignent avec un crochet mâle / femelle rapide.
- Ils ne peuvent pas être joints à des éléments suspendus.

# LARA 106 bracciolo basso programma / *bras bas programme*

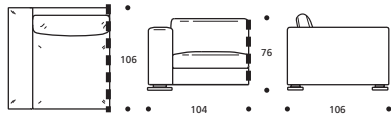
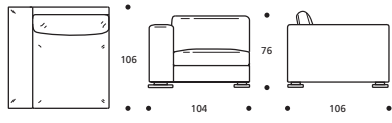
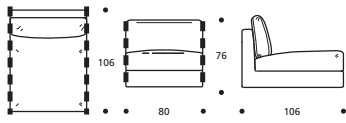
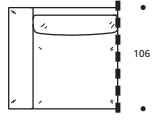
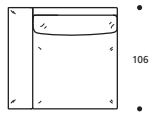
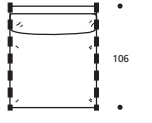
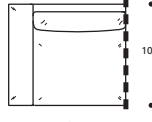
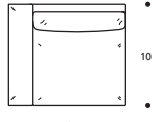
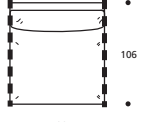
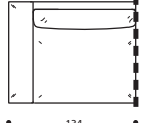
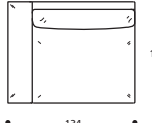
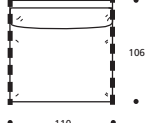
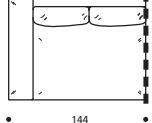
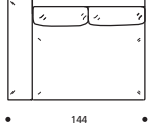
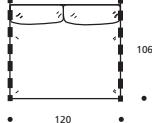
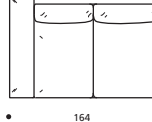
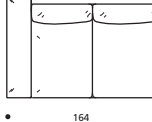
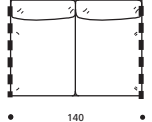
 <p><b>Art. 1810</b> 104 x 106 x h. 76 cm</p>	 <p><b>Art. 1816</b> 104 x 106 x h. 76 cm</p>		 <p><b>Art. 1830</b> 80 X 106 X h. 76 cm</p>
 <p><b>Art. 1811</b> 114 x 106 x h. 76 cm</p>	 <p><b>Art. 1817</b> 114 x 106 x h. 76 cm</p>		 <p><b>Art. 1831</b> 90 X 106 X h. 76 cm</p>
 <p><b>Art. 1812</b> 124 x 106 x h. 76 cm</p>	 <p><b>Art. 1818</b> 124 x 106 x h. 76 cm</p>		 <p><b>Art. 1832</b> 100 X 106 X h. 76 cm</p>
 <p><b>Art. 1813</b> 134 x 106 x h. 76 cm</p>	 <p><b>Art. 1819</b> 134 x 106 x h. 76 cm</p>		 <p><b>Art. 1833</b> 110 X 106 X h. 76 cm</p>
 <p><b>Art. 1814</b> 144 x 106 x h. 76 cm</p>	 <p><b>Art. 1820</b> 144 x 106 x h. 76 cm</p>		 <p><b>Art. 1834</b> 120 X 106 X h. 76 cm</p>
 <p><b>Art. 1815</b> 164 x 106 x h. 76 cm</p>	 <p><b>Art. 1821</b> 164 x 106 x h. 76 cm</p>		 <p><b>Art. 1835</b> 140 X 106 X h. 76 cm</p>

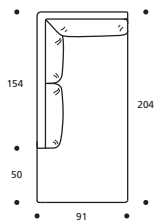

**Art. 1865** 91 X 204 X h. 76 cm

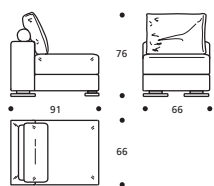

**Art. 1827** 91 X 66 X h. 76 cm

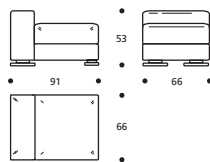

**Art. 1829** 91 X 66 X h. 53 cm

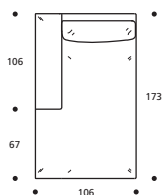

**Art. 1825** 106 X 173 X h. 76 cm

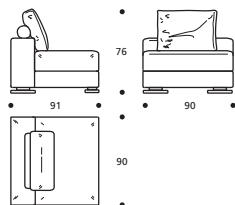

**Art. 1826** 91 X 90 X h. 76 cm

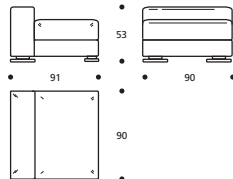

**Art. 1828** 91 X 90 X h. 53 cm

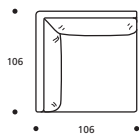

**Art. 1824** 106 X 106 X h. 76 cm



**Art. 0140** 60 X 45 X h. 7/16 cm

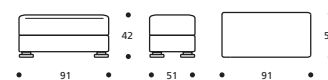

**Art. 1849** 91 X 51 X h. 40/42 cm

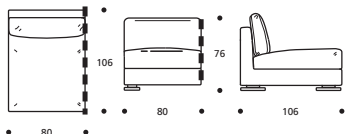

**Art. 1836** 80 X 106 X h. 76 cm



**Art. 0133** 40 X 40 X h. 5/13 cm

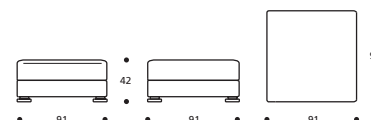

**Art. 1864** 91 X 91 X h. 40/42 cm

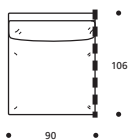

**Art. 1837** 90 X 106 X h. 76 cm



**Art. 0132** 50 X 45 X h. 7/16 cm

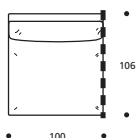

**Art. 1838** 100 X 106 X h. 76 cm



**Art. 0131** 60 X 45 X h. 7/16 cm

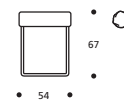

**Art. 1466** 54 X h. 67 X Ø 12 cm

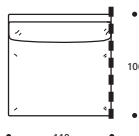

**Art. 1839** 110 X 106 X h. 76 cm



**Art. 0130** 50 X 50 X h. 8/18 cm

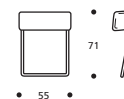

**Art. 0151** 55 X h. 71 cm

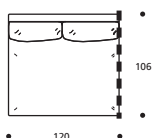

**Art. 1840** 120 X 106 X h. 76 cm



**Art. 1528** 50 X 50 X h. 8/15 cm

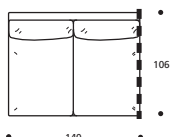

**Art. 1841** 140 X 106 X h. 76 cm



**Art. 0116** 60/65 X 60/65 X h. 0/16 cm